



Flat Display Connections (FDC) AXOLINK[®]

www.axon-cable.com

axon'
cable & interconnect 

Flat Cable Assemblies



FDC-Flat Display Connections AXOLINK™

FDC-Flat Display Connections are made from AXOJUMP™ Flat Flexible Cables and industry standard display connectors such as DF-9, DF-19, FI-SE or FI-X.

Advantages

Small dimensions: low profile, narrow width design,
Low cost, high reliability,
Excellent flexibility and flex-life.

General characteristics

0.50 mm, 1.00 mm and 1.25 mm pitches,
Standard FFC, ZIF interface
FDC with DF-9 cable assemblies are compliant with VESA (Video Electronics Standard Association) FPGI-1 (Flat Panel Display Interface),



31 WAY FDC WITH DF-9 CONNECTOR

Product availability

	Connector type			
	DF-9**	DF-19*	FI-SE*	FI-X*
FFC type				
0.50 (mm)	x			
1.00 (mm)		x		x
1.25 (mm)			x	
Number of conductors				
14		x		x
20		x	x	x
30		x		x
31	x			
41	x			

*Standard version is shielded for these connector types. Non shielded versions also available.

**Standard version is non-shielded (shielded version on request).

All versions can be supplied with custom folds.

Processing forms

■ M: Header
■ F: Receptacle

DF9

Non-shielded version (FDC), Shielded version on request.

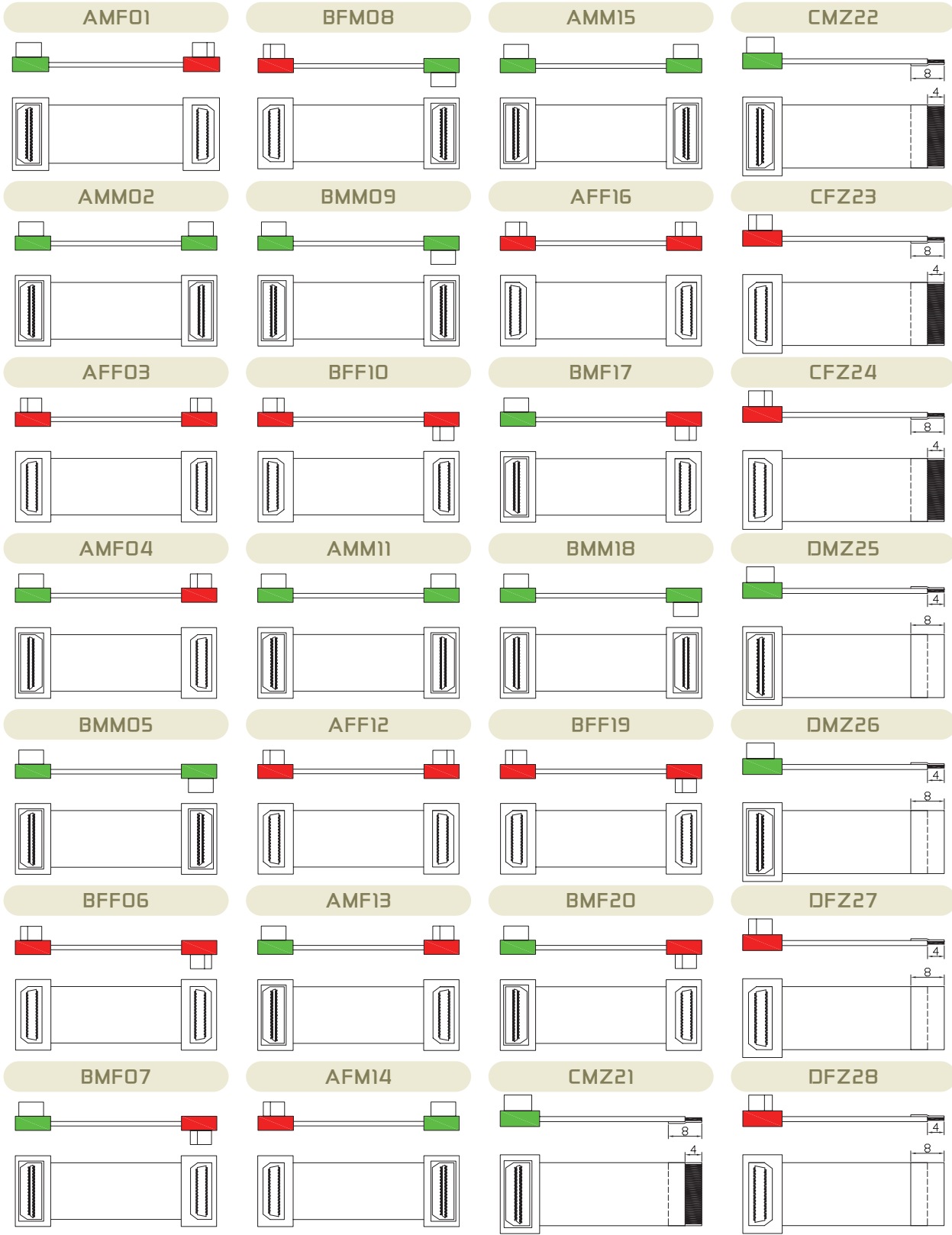

DF19

Non-shielded version (FDC), shielded version (FDB).

EMM29

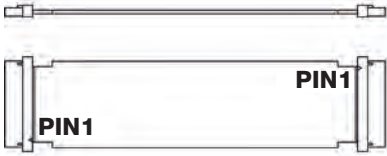

EMM30

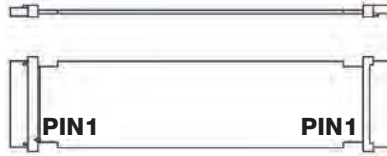

FMZ31



FMZ32

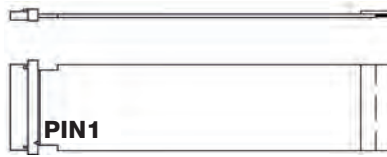

FDC WITH DF-19 CONNECTOR

FI-SE

Non-shielded version (FDC), shielded version (FDB).

EMM33

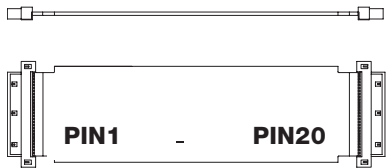

EMM34

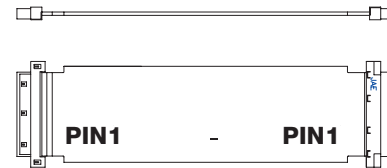

FMZ35

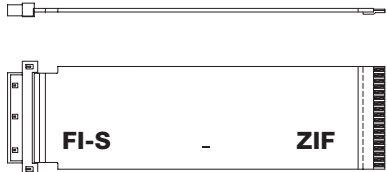

FMZ36

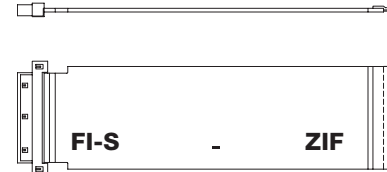

41 WAY FDC WITH DF-9 CONNECTOR

FI-X

Non-shielded version (FDC), shielded version (FDB).

EMM37

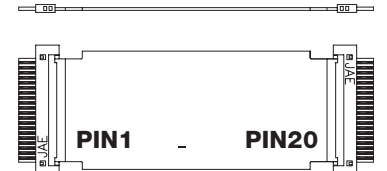

EMM38



FMZ39

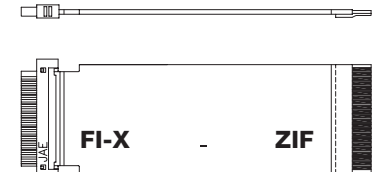

FMZ40

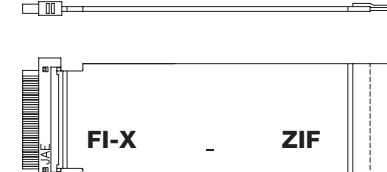

41 WAY FDC WITH DF-9 CONNECTOR

Dimensions

DF-9

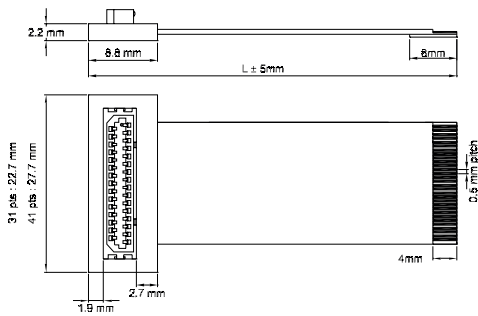

DF-19

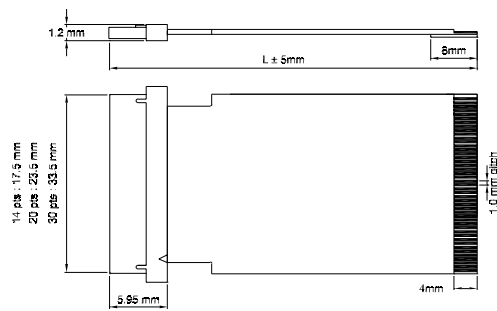

FI-SE

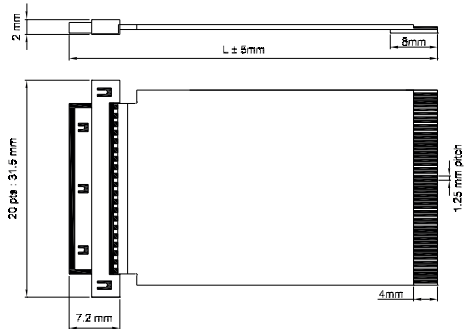

FI-X

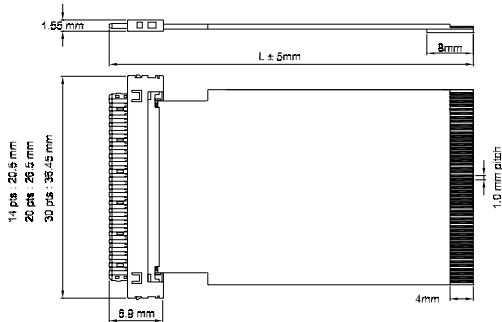

Where there is a ZIF connector at one end, the standard number of ways for the ZIF will be 2 more than the DF-19/FI-SE/FI-X connector at the other end (for DF-9 versions the number of ways is equal for both connectors). If same number of ways (14, 20 or 30) is required for the ZIF on DF-19/FI-SE/FI-X versions, AXON' can punch the ZIF end to ensure compatibility.

Off-the-shelf products

AXON' keeps several standard lengths of Flat Flexible Cables in stock with 31 or 41 conductors for the different assembly types to assure a short delivery time. Immediately after receipt of your order, the termination process is started. Any connector configuration shown on the following pages is possible.

Standard AXOLINK™ assembly lengths

- 76 mm
- 102 mm
- 152 mm
- 203 mm
- 254 mm

Processing forms

Connection schemes

Only for
DF-9

A

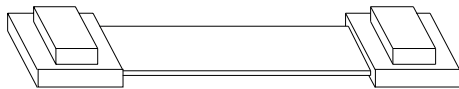

B

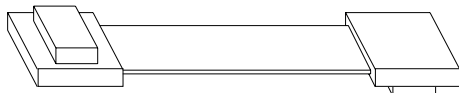

C

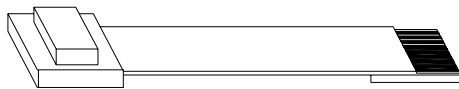

D

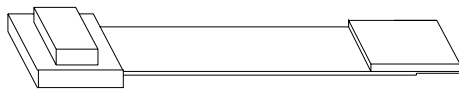

Only for
DF-19, FI-SE and FI-X

E

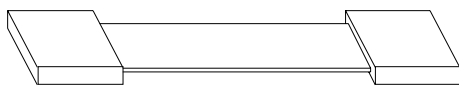

F

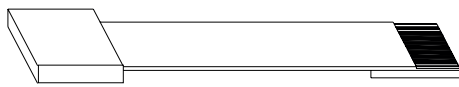

For "ZIF" ending of DF-19 / FI-SE / FI-X versions, connector ways = number of conductors + 2.

Quick prototyping for electrical validation

AXON' can provide small quantities of AXOLINK™ prototypes for electrical validation. Dependent on the availability of cable, AXON' may propose the exact length required or a slightly different length to provide the quickest response.

Special products

AXON' can also provide special AXOLINK™ products, in particular:

- special number of conductors
- special markings,
- any special length,
- moisture protection of the assembly,
- folded versions,
- ferrites on the assembly,
- shielding,
- shielding with grounding,
- gold plating: for DF-19/FI-SE and FI-X the gold plating available on the ZIF end.

Identification code

FDC 41 / 0100 A M M 02

Connection scheme

1 through 40 as defined on the connection scheme

Connector type C2

M: MALE (Header) - DF-9 / DF-19 / FI-SE / FI-X
F: FEMALE (Receptacle) - DF-9 only
Z: ZIF

Connector type C1

M: MALE (Header) - DF-9 / DF-19 / FI-SE / FI-X
F: FEMALE (Receptacle) - DF-9 only

Connection type

A: connector-connector - same face
B: connector-connector - opposite face
C: DF-9 to ZIF - same face
D: DF-9 to ZIF - opposite face
E: connector - connector (only for DF-19 / FI-SE / FI-X)
F: connector - ZIF (only for DF-19 / FI-SE / FI-X)

Length

End to end length including connector (mm)
(minimum length : 52 mm)

Number of conductors

31 or 41 for DF-9
14, 20 or 30 for DF-19
20 for FI-SE
14, 20 or 30 for FI-X

FDC = Non shielded version

(DF-9, DF-19, FI-SE, FI-X connectors)

FDB = Shielded version

(DF-9, DF-19, FI-SE, FI-X connectors)

Any special version on request

>> BRAZIL

AXON' CABLE INDUSTRIA E COMÉRCIO LTDA

Av. Afonso Arinos de Melo Franco
222 sala 276 bloco 2b
Barra da Tijuca - CEP.: 22631-455
RIO DE JANEIRO-RJ
TEL.: +55 21 3596-8002
e-mail: l.moreira@axon-cable.com

>> CANADA

AXON' CABLE CANADIAN OFFICE

4578 rue Chabot
H2H 1Y3 MONTREAL, QUEBEC
TEL.: +1 514 898 2044
e-mail: g.hannequin@axoncable.com

>> CHINA

AXON' INTERCONNECT LTD

High Tech Industrial Park,
Chang Bao XI Road
Ronggui, 528306
SHUNDE, GUANGDONG
TEL.: +86 757 2838 7200
FAX: +86 757 2838 7212
e-mail: sales@axon-interconnect.com

>> GERMANY

AXON' KABEL GMBH

Postfach 1131 - 71201 LEONBERG
Hertichstr. 43 - 71229 LEONBERG
TEL.: +49 7152-97992-0
FAX: +49 7152-97992-7
e-mail: sales@axon-cable.de

>> HUNGARY

AXON' KÁBELGYÁRTÓ KFT.

KÜLSŐ-SZEGEDI ÚT 104.
H-6000 KECSKEMÉT,
TEL.: +36 76 508 195
FAX: +36 76 508 196
e-mail: axon@axon-cable.hu

>> INDIA

AXON' INTERCONNECTORS AND WIRES PVT LTD

#117, Neil Rao Towers, Suite No. 1W,
Road No. 3 EPIP, Whitefield
BANGALORE - 560 066
TEL.: +91 80 40918186
FAX: +91 80 40918185
e-mail: sales@axon-cable.in

>> JAPAN

AXON' CABLE JAPAN OFFICE

TEL./FAX: +81 26 244 2261
e-mail: axon-japan@axon-cable.com

>> LATVIA

AXON' CABLE SIA

Višku Iela, 21 C - LV-5410 DAUGAVPILS
TEL.: +371 6540 78 91
FAX: +371 6540 78 93
e-mail: axon@axoncable.lv

>> MEXICO

AXON' INTERCONEX, S.A. DE C.V.

Av. Peñuelas 21-A1.
Industrial San Pedrito Peñuelas
Querétaro Park
76148 Querétaro, Qro.
TEL: +52 442 215 2713
FAX: +52 442 220 6464
e-mail: axon-mexico@axoncable.com

>> SPAIN

AXON' CABLE SPANISH OFFICE

C/Capitán Haya, N°1, Planta 15
28020 MADRID
TEL.: +34 91 418 43 46
FAX: +34 91 556 28 80
e-mail: sales@axon-cable.com

>> UNITED KINGDOM

AXON' CABLE LTD

AXON' AGORA

Admiralty Park - ROSYTH DUNFERMLINE
FIFE KY11 2YW
TEL.: +44 1383 421500
FAX: +44 8715 282789
e-mail: sales@axon-cable.co.uk

>> USA

AXON' CABLE INC.

1314 N Plum Grove Road
SCHAUMBURG, IL. 60173
TEL.: +1 847 230 7800
FAX: +1 847 230 7849
e-mail: sales@axoncable.com

HEADQUARTERS

>> France

VISIT OUR WEBSITE
www.axon-cable.com



FOLLOW US



axon'
cable & interconnect

>> AXON' CABLE S.A.S.

2 ROUTE DE CHALONS EN CHAMPAGNE - 51210 MONTMIRAIL
TEL : +33 3 26 81 70 00 - FAX : +33 3 26 81 28 83
e-mail : sales@axon-cable.com - <http://www.axon-cable.com>